

---

# Inference in First-Order Logic

Philipp Koehn

16 March 2017



# A Brief History of Reasoning



450B.C.	<b>Stoics</b>	propositional logic, inference (maybe)
322B.C.	<b>Aristotle</b>	“syllogisms” (inference rules), quantifiers
1565	<b>Cardano</b>	probability theory (propositional logic + uncertainty)
1847	<b>Boole</b>	propositional logic (again)
1879	<b>Frege</b>	first-order logic
1922	<b>Wittgenstein</b>	proof by truth tables
1930	<b>Gödel</b>	$\exists$ complete algorithm for FOL
1930	<b>Herbrand</b>	complete algorithm for FOL (reduce to propositional)
1931	<b>Gödel</b>	$\neg\exists$ complete algorithm for arithmetic
1960	<b>Davis/Putnam</b>	“practical” algorithm for propositional logic
1965	<b>Robinson</b>	“practical” algorithm for FOL—resolution

# The Story So Far



- Propositional logic
- Subset of propositional logic: horn clauses
- Inference algorithms
  - forward chaining
  - backward chaining
  - resolution (for full propositional logic)
- First order logic (FOL)
  - variables
  - functions
  - quantifiers
  - etc.
- Today: inference for first order logic

# Outline



- Reducing first-order inference to propositional inference
- Unification
- Generalized Modus Ponens
- Forward and backward chaining
- Logic programming
- Resolution

# reduction to propositional inference

# Universal Instantiation



- Every instantiation of a universally quantified sentence is entailed by it:

$$\frac{\forall v \alpha}{\text{SUBST}(\{v/g\}, \alpha)}$$

for any variable  $v$  and ground term  $g$  ■

- E.g.,  $\forall x \text{ King}(x) \wedge \text{Greedy}(x) \implies \text{Evil}(x)$  yields

$$\text{King}(\text{John}) \wedge \text{Greedy}(\text{John}) \implies \text{Evil}(\text{John})$$

$$\text{King}(\text{Richard}) \wedge \text{Greedy}(\text{Richard}) \implies \text{Evil}(\text{Richard})$$

$$\text{King}(\text{Father}(\text{John})) \wedge \text{Greedy}(\text{Father}(\text{John})) \implies \text{Evil}(\text{Father}(\text{John}))$$

⋮

# Existential Instantiation



- For any sentence  $\alpha$ , variable  $v$ , and constant symbol  $k$  that does not appear elsewhere in the knowledge base:

$$\frac{\exists v \alpha}{\text{SUBST}(\{v/k\}, \alpha)} \blacksquare$$

- E.g.,  $\exists x \text{Crown}(x) \wedge \text{OnHead}(x, \text{John})$  yields

$$\text{Crown}(C_1) \wedge \text{OnHead}(C_1, \text{John})$$

provided  $C_1$  is a new constant symbol, called a **Skolem constant**

# Instantiation



- Universal Instantiation
  - can be applied several times to **add** new sentences
  - the new KB is logically equivalent to the old
  
- Existential Instantiation
  - can be applied once to **replace** the existential sentence
  - the new KB is **not** equivalent to the old
  - but is satisfiable iff the old KB was satisfiable



# Reduction to Propositional Inference



8

- Suppose the KB contains just the following:

$$\forall x \text{ King}(x) \wedge \text{Greedy}(x) \implies \text{Evil}(x)$$

*King(John)*

*Greedy(John)*

*Brother(Richard, John)*

- Instantiating the universal sentence in **all possible** ways, we have

$$\text{King}(\text{John}) \wedge \text{Greedy}(\text{John}) \implies \text{Evil}(\text{John})$$

$$\text{King}(\text{Richard}) \wedge \text{Greedy}(\text{Richard}) \implies \text{Evil}(\text{Richard})$$

*King(John)*

*Greedy(John)*

*Brother(Richard, John)*

- The new KB is **propositionalized**: proposition symbols are

*King(John), Greedy(John), Evil(John), Brother(Richard, John), etc.*

# Reduction to Propositional Inference



- Claim: a ground sentence\* is entailed by new KB iff entailed by original KB
- Claim: every FOL KB can be propositionalized so as to preserve entailment
- Idea: propositionalize KB and query, apply resolution, return result■
- Problem: with function symbols, there are infinitely many ground terms, e.g., *Father(Father(Father(John)))*■
- Theorem: Herbrand (1930). If a sentence  $\alpha$  is entailed by an FOL KB, it is entailed by a **finite** subset of the propositional KB
- Idea: For  $n = 0$  to  $\infty$  do  
create a propositional KB by instantiating with depth- $n$  terms  
see if  $\alpha$  is entailed by this KB■
- Problem: works if  $\alpha$  is entailed, loops if  $\alpha$  is not entailed■
- Theorem: Turing (1936), Church (1936), entailment in FOL is **semidecidable**

# Practical Problems with Propositionalization<sup>10</sup>



- Propositionalization seems to generate lots of irrelevant sentences.

- E.g., from
$$\forall x \text{ King}(x) \wedge \text{Greedy}(x) \implies \text{Evil}(x)$$
$$\text{King}(\text{John})$$
$$\forall y \text{ Greedy}(y)$$
$$\text{Brother}(\text{Richard}, \text{John})$$

it seems obvious that  $\text{Evil}(\text{John})$ , but propositionalization produces lots of facts such as  $\text{Greedy}(\text{Richard})$  that are irrelevant

- With  $p$   $k$ -ary predicates and  $n$  constants, there are  $p \cdot n^k$  instantiations
- With function symbols, it gets much much worse!



# unification

# Plan



- We have the inference rule
  - $\forall x \text{ King}(x) \wedge \text{Greedy}(x) \implies \text{Evil}(x)$
- We have facts that (partially) match the precondition
  - $\text{King}(\text{John})$
  - $\forall y \text{ Greedy}(y)$
- We need to match them up with substitutions:  $\theta = \{x/\text{John}, y/\text{John}\}$  works
  - unification
  - generalized modus ponens

# Unification

- $\text{UNIFY}(\alpha, \beta) = \theta$  if  $\alpha\theta = \beta\theta$

$p$	$q$	$\theta$
$\text{Knows}(\text{John}, x)$	$\text{Knows}(\text{John}, \text{Jane})$	
$\text{Knows}(\text{John}, x)$	$\text{Knows}(y, \text{Mary})$	
$\text{Knows}(\text{John}, x)$	$\text{Knows}(y, \text{Mother}(y))$	
$\text{Knows}(\text{John}, x)$	$\text{Knows}(x, \text{Mary})$	

# Unification

- $\text{UNIFY}(\alpha, \beta) = \theta$  if  $\alpha\theta = \beta\theta$

$p$	$q$	$\theta$
$\text{Knows}(\text{John}, x)$	$\text{Knows}(\text{John}, \text{Jane})$	$\{x/\text{Jane}\}$
$\text{Knows}(\text{John}, x)$	$\text{Knows}(y, \text{Mary})$	
$\text{Knows}(\text{John}, x)$	$\text{Knows}(y, \text{Mother}(y))$	
$\text{Knows}(\text{John}, x)$	$\text{Knows}(x, \text{Mary})$	

# Unification

- $\text{UNIFY}(\alpha, \beta) = \theta$  if  $\alpha\theta = \beta\theta$

$p$	$q$	$\theta$
$\text{Knows}(\text{John}, x)$	$\text{Knows}(\text{John}, \text{Jane})$	$\{x/\text{Jane}\}$
$\text{Knows}(\text{John}, x)$	$\text{Knows}(y, \text{Mary})$	$\{x/\text{Mary}, y/\text{John}\}$
$\text{Knows}(\text{John}, x)$	$\text{Knows}(y, \text{Mother}(y))$	
$\text{Knows}(\text{John}, x)$	$\text{Knows}(x, \text{Mary})$	



# Unification

- $\text{UNIFY}(\alpha, \beta) = \theta$  if  $\alpha\theta = \beta\theta$

$p$	$q$	$\theta$
$\text{Knows}(\text{John}, x)$	$\text{Knows}(\text{John}, \text{Jane})$	$\{x/\text{Jane}\}$
$\text{Knows}(\text{John}, x)$	$\text{Knows}(y, \text{Mary})$	$\{x/\text{Mary}, y/\text{John}\}$
$\text{Knows}(\text{John}, x)$	$\text{Knows}(y, \text{Mother}(y))$	$\{y/\text{John}, x/\text{Mother}(\text{John})\}$
$\text{Knows}(\text{John}, x)$	$\text{Knows}(x, \text{Mary})$	

# Unification

- $\text{UNIFY}(\alpha, \beta) = \theta$  if  $\alpha\theta = \beta\theta$

$p$	$q$	$\theta$
$\text{Knows}(\text{John}, x)$	$\text{Knows}(\text{John}, \text{Jane})$	$\{x/\text{Jane}\}$
$\text{Knows}(\text{John}, x)$	$\text{Knows}(y, \text{Mary})$	$\{x/\text{Mary}, y/\text{John}\}$
$\text{Knows}(\text{John}, x)$	$\text{Knows}(y, \text{Mother}(y))$	$\{y/\text{John}, x/\text{Mother}(\text{John})\}$
$\text{Knows}(\text{John}, x)$	$\text{Knows}(x, \text{Mary})$	<i>fail</i> ■

- Standardizing apart eliminates overlap of variables, e.g.,  $\text{Knows}(z_{17}, \text{Mary})$

$$\text{Knows}(\text{John}, x) \mid \text{Knows}(z_{17}, \text{Mary}) \mid \{z_{17}/\text{John}, x/\text{Mary}\}$$

# generalized modus ponens

# Generalized Modus Ponens

- Generalized modus ponens used with KB of **definite clauses** (exactly one positive literal)
- All variables assumed universally quantified

$$\frac{p_1', p_2', \dots, p_n', (p_1 \wedge p_2 \wedge \dots \wedge p_n \Rightarrow q)}{q\theta} \quad \text{where } p_i'\theta = p_i\theta \text{ for all } i$$

- Rule:  $King(x) \wedge Greedy(x) \implies Evil(x)$ ■
  - Precondition of rule:  $p_1$  is  $King(x)$        $p_2$  is  $Greedy(x)$
  - Implication:  $q$  is  $Evil(x)$ ■
  - Facts:  $p_1'$  is  $King(John)$        $p_2'$  is  $Greedy(y)$ ■
  - Substitution:  $\theta$  is  $\{x/John, y/John\}$
- $\Rightarrow$  Result of modus ponens:  $q\theta$  is  $Evil(John)$

# forward chaining

# Example Knowledge

- *The law says that it is a crime for an American to sell weapons to hostile nations. The country Nono, an enemy of America, has some missiles, and all of its missiles were sold to it by Colonel West, who is American.*
  
- Prove that Col. West is a criminal

# Example Knowledge Base

- ... it is a crime for an American to sell weapons to hostile nations:■  
 $American(x) \wedge Weapon(y) \wedge Sells(x, y, z) \wedge Hostile(z) \implies Criminal(x)$
- Nono ... has some missiles, i.e.,  $\exists x Owns(Nono, x) \wedge Missile(x)$ :  
 $Owns(Nono, M_1)$  and  $Missile(M_1)$
- ... all of its missiles were sold to it by Colonel West■  
 $\forall x Missile(x) \wedge Owns(Nono, x) \implies Sells(West, x, Nono)$
- Missiles are weapons:■  
 $Missile(x) \implies Weapon(x)$
- An enemy of America counts as “hostile”:■  
 $Enemy(x, America) \implies Hostile(x)$
- West, who is American ...  
 $American(West)$
- The country Nono, an enemy of America ...  
 $Enemy(Nono, America)$

# Forward Chaining Proof

*American(West)*

*Missile(MI)*

*Owns(Nono, MI)*

*Enemy(Nono, America)*



# Forward Chaining Proof

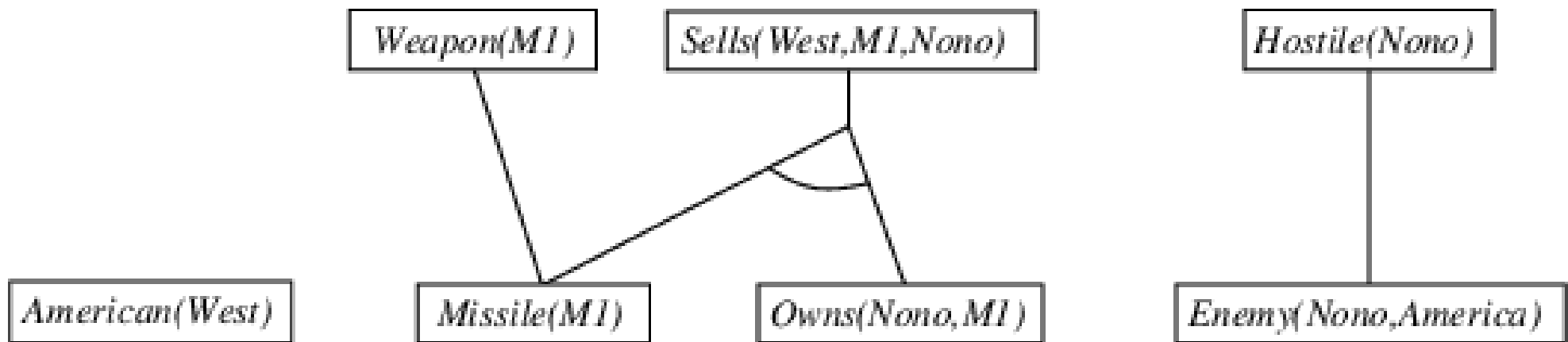

(Note:  $\forall x \text{ Missile}(x) \wedge \text{Owns}(\text{Nono}, x) \implies \text{Sells}(\text{West}, x, \text{Nono})$ )

# Forward Chaining Proof

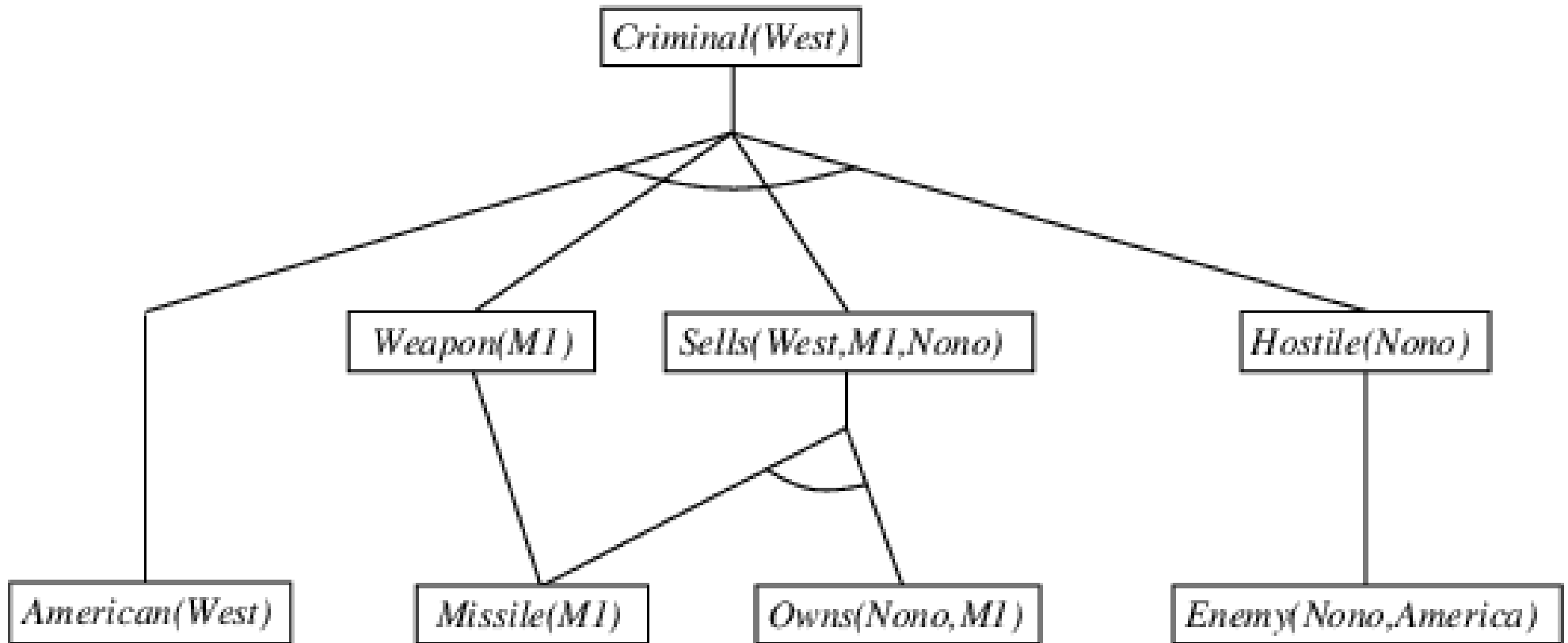

(Note:  $American(x) \wedge Weapon(y) \wedge Sells(x, y, z) \wedge Hostile(z) \implies Criminal(x)$ )

# Properties of Forward Chaining



- Sound and complete for first-order definite clauses (proof similar to propositional proof)
- **Datalog** (1977) = first-order definite clauses + no functions (e.g., crime KB)  
Forward chaining terminates for Datalog in poly iterations: at most  $p \cdot n^k$  literals
- May not terminate in general if  $\alpha$  is not entailed
- This is unavoidable: entailment with definite clauses is semidecidable

# Efficiency of Forward Chaining



- Simple observation: no need to match a rule on iteration  $k$  if a premise wasn't added on iteration  $k - 1$   
     $\implies$  match each rule whose premise contains a newly added literal
- Matching itself can be expensive
- Database indexing allows  $O(1)$  retrieval of known facts  
    e.g., query  $Missile(x)$  retrieves  $Missile(M_1)$
- Matching conjunctive premises against known facts is NP-hard
- Forward chaining is widely used in deductive databases

# Hard Matching Example

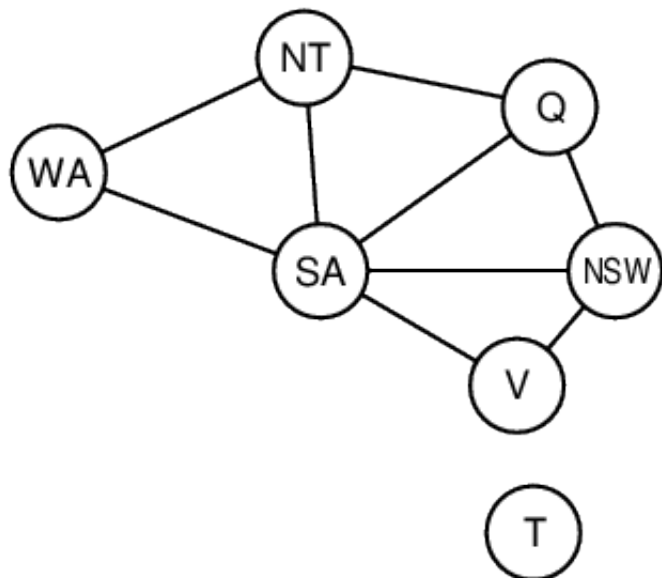

$$\begin{aligned}
 & Diff(wa, nt) \wedge Diff(wa, sa) \wedge \\
 & Diff(nt, q) Diff(nt, sa) \wedge \\
 & Diff(q, nsw) \wedge Diff(q, sa) \wedge \\
 & Diff(nsw, v) \wedge Diff(nsw, sa) \wedge \\
 & Diff(v, sa) \implies Colorable()
 \end{aligned}$$

$$\begin{aligned}
 & Diff(Red, Blue) \quad Diff(Red, Green) \\
 & Diff(Green, Red) \quad Diff(Green, Blue) \\
 & Diff(Blue, Red) \quad Diff(Blue, Green)
 \end{aligned}$$

- *Colorable()* is inferred iff the constraint satisfaction problem has a solution
- CSPs include 3SAT as a special case, hence matching is NP-hard

# Forward Chaining Algorithm

```
function FOL-FC-Ask( $KB, \alpha$ ) returns a substitution or false
  repeat until new is empty
    new  $\leftarrow \emptyset$ 
    for each sentence  $r$  in  $KB$  do
       $(p_1 \wedge \dots \wedge p_n \implies q) \leftarrow \text{STANDARDIZE-APART}(r)$ 
      for each  $\theta$  such that  $(p_1 \wedge \dots \wedge p_n)\theta = (p'_1 \wedge \dots \wedge p'_n)\theta$ 
        for some  $p'_1, \dots, p'_n$  in  $KB$ 
           $q' \leftarrow \text{SUBST}(\theta, q)$ 
          if  $q'$  is not a renaming of a sentence already in  $KB$  or new then do
            add  $q'$  to new
             $\phi \leftarrow \text{UNIFY}(q', \alpha)$ 
            if  $\phi$  is not fail then return  $\phi$ 
      add new to  $KB$ 
  return false
```

# backward chaining

# Backward Chaining



- Start with query
- Check if it can be derived by given rules and facts
  - apply rules that infer the query
  - recurse over pre-conditions



# Backward Chaining Example



*Criminal(West)*

# Backward Chaining Example

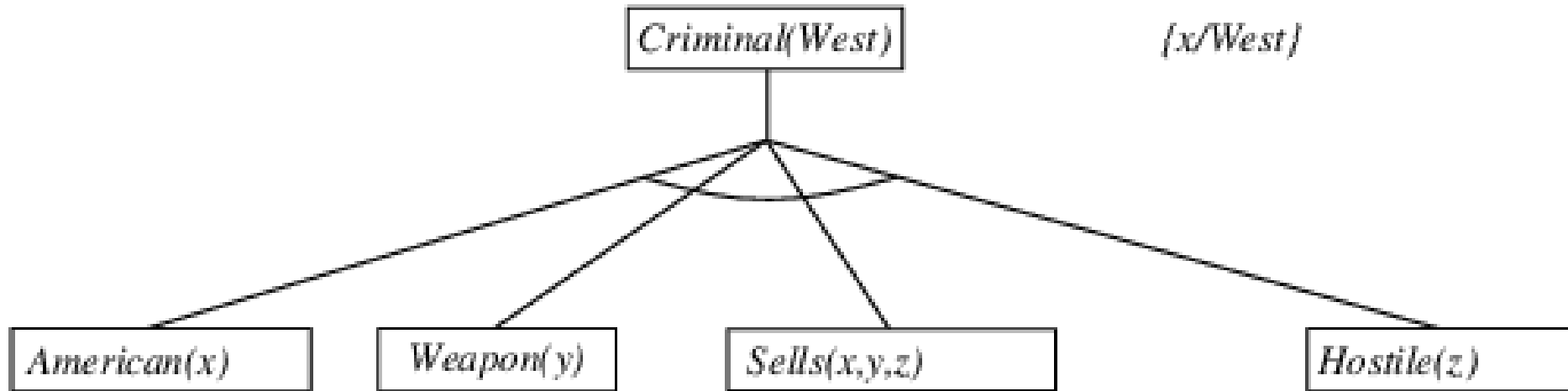

# Backward Chaining Example

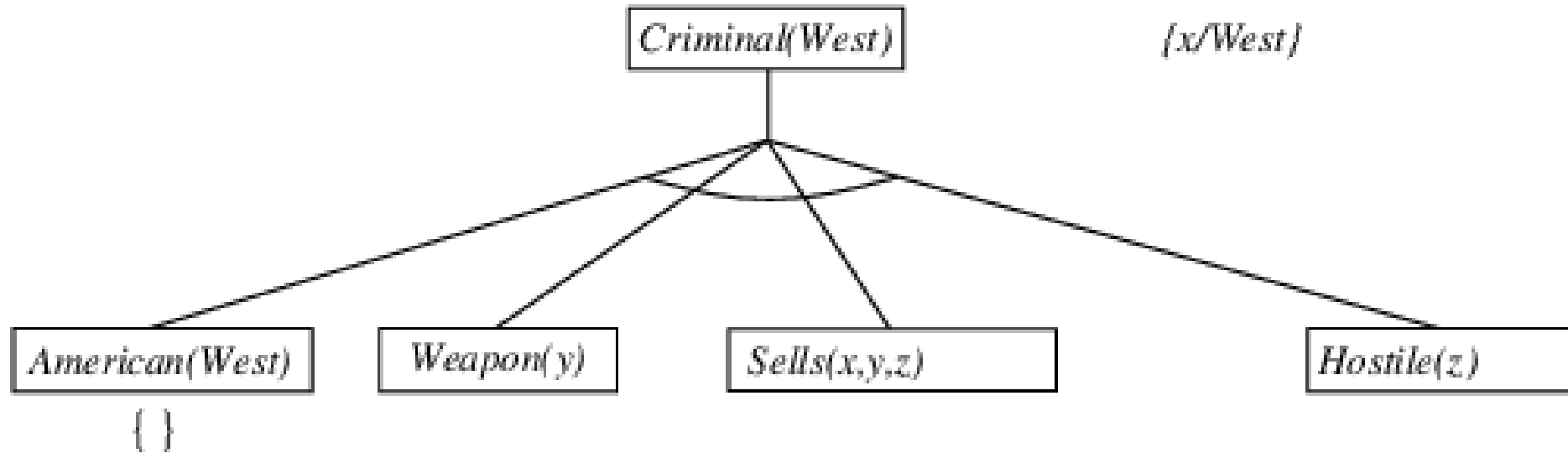

# Backward Chaining Example

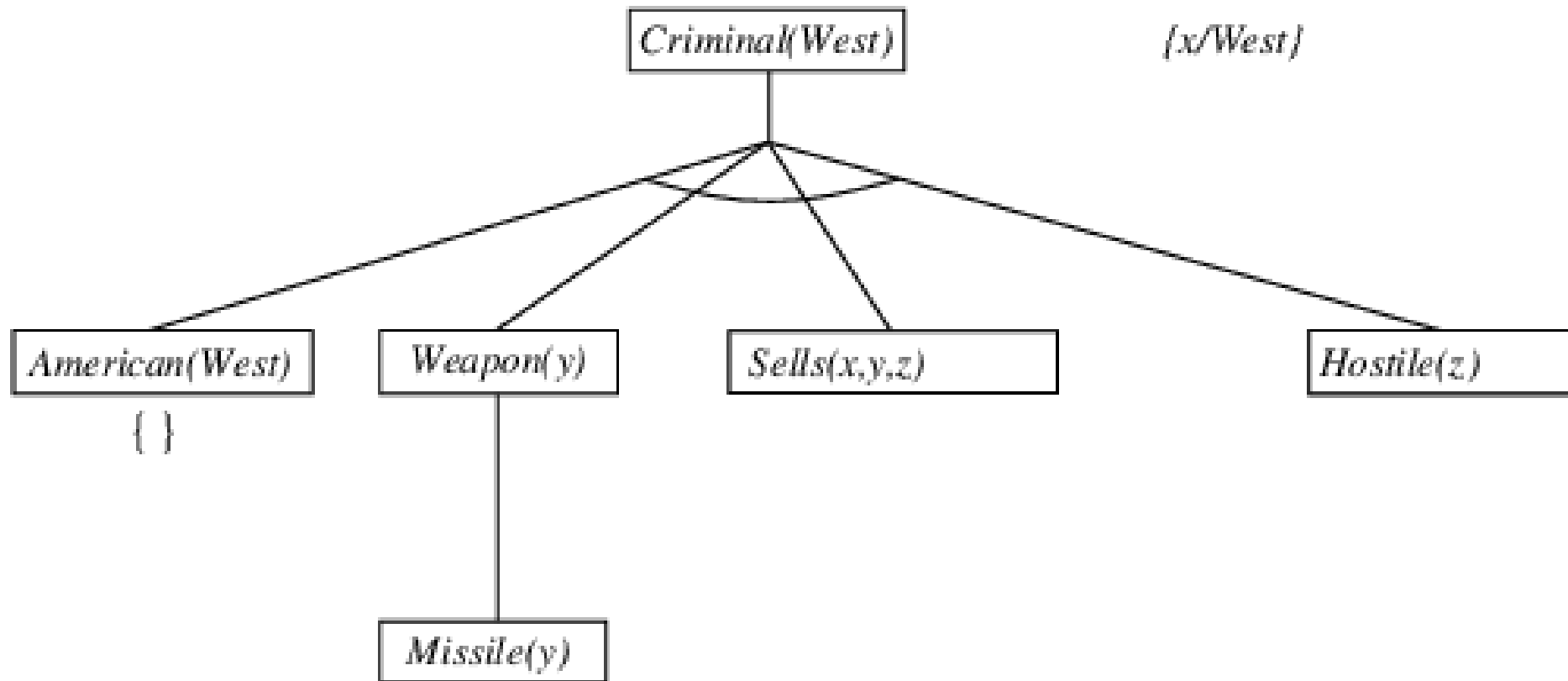

# Backward Chaining Example

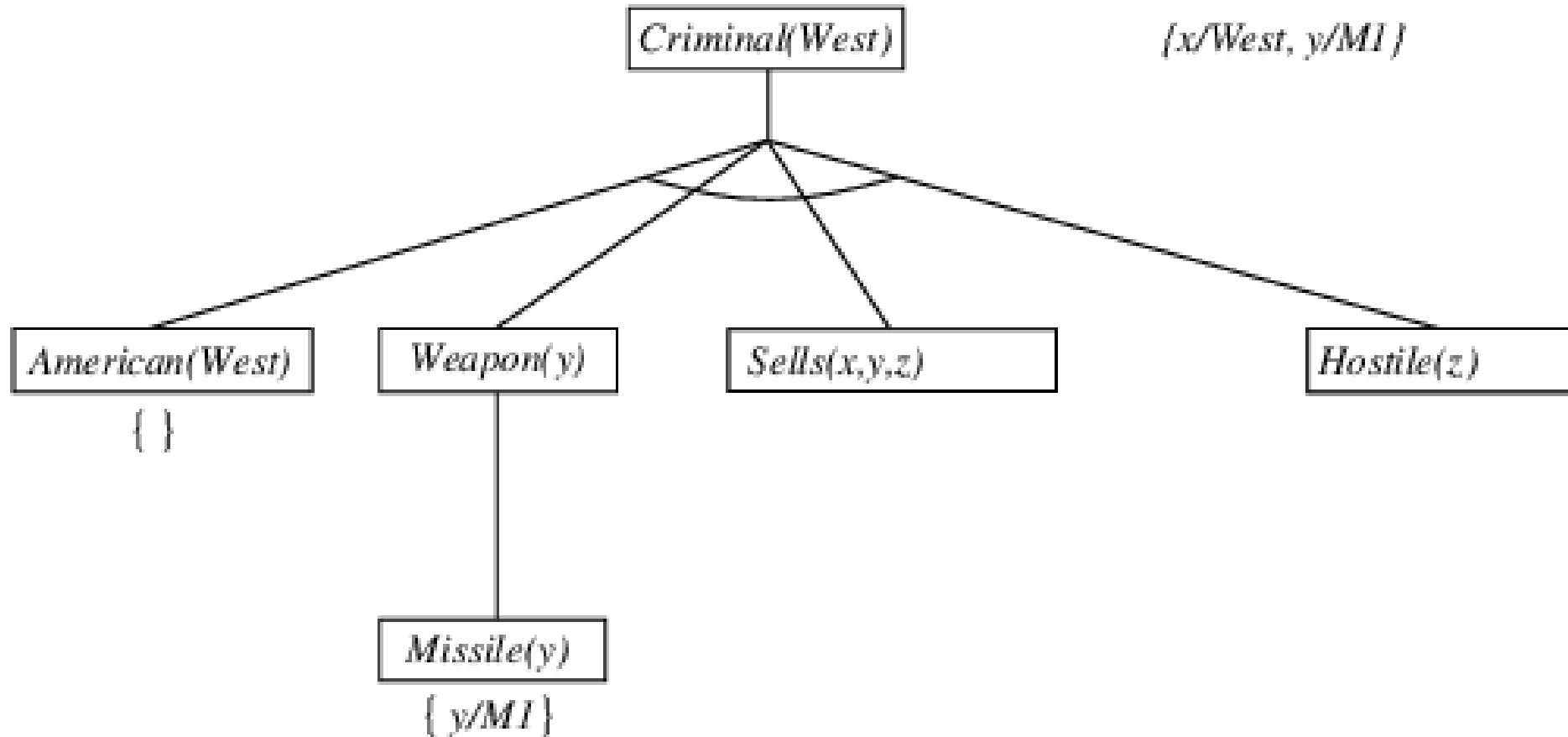

# Backward Chaining Example

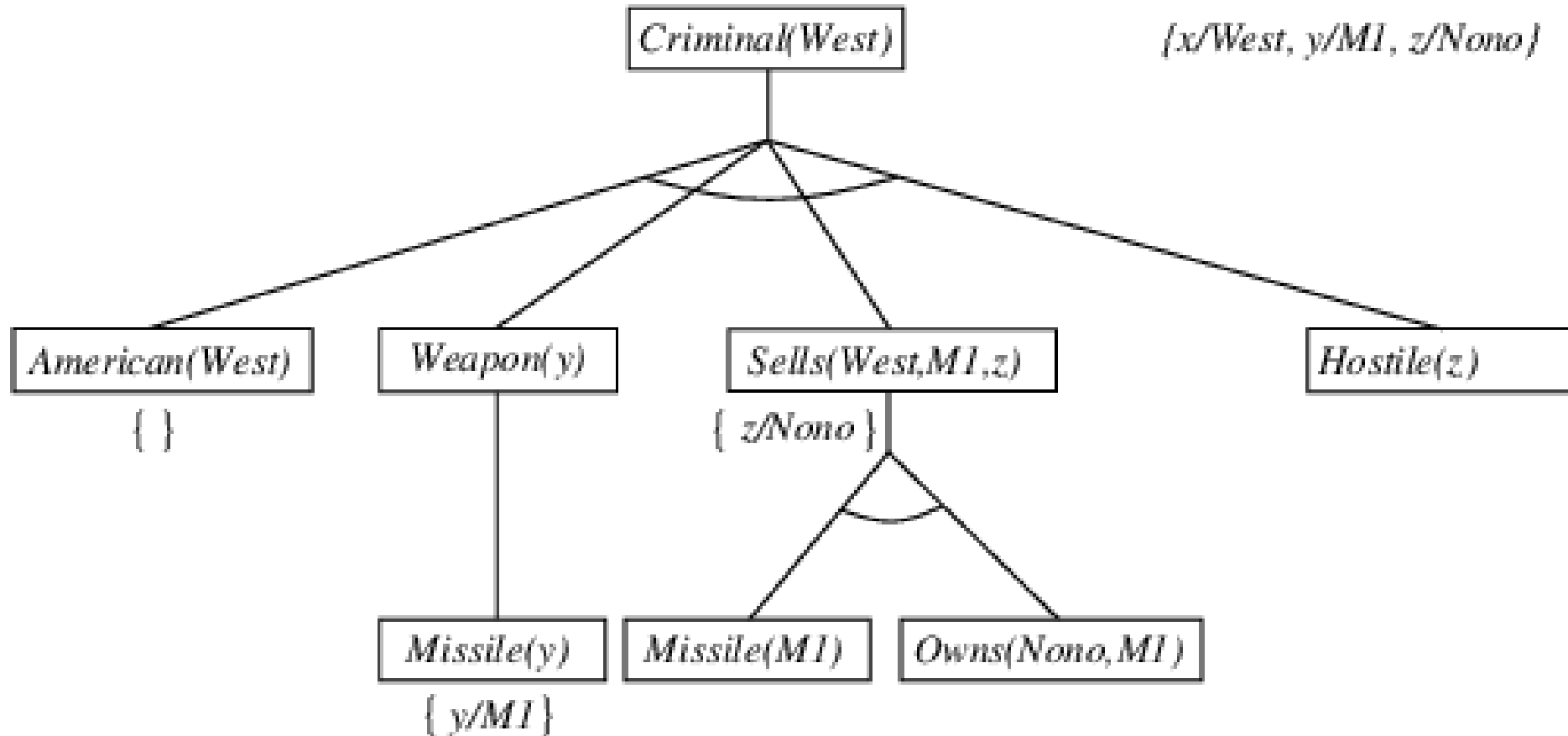

# Backward Chaining Example

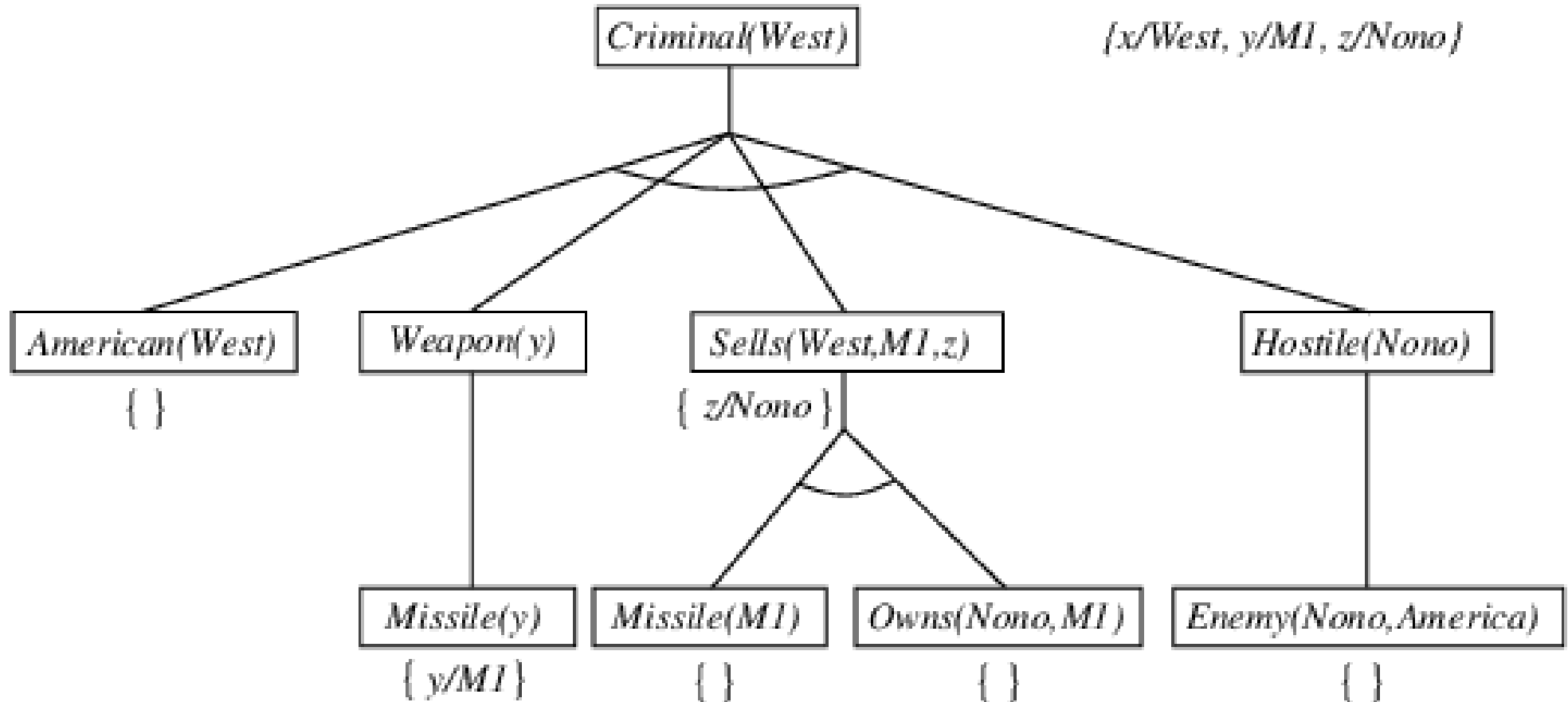

# Properties of Backward Chaining



- Depth-first recursive proof search: space is linear in size of proof
- Incomplete due to infinite loops  
     $\implies$  fix by checking current goal against every goal on stack
- Inefficient due to repeated subgoals (both success and failure)  
     $\implies$  fix using caching of previous results (extra space!)
- Widely used (without improvements!) for **logic programming**



# Backward Chaining Algorithm



```
function FOL-BC-ASK(KB, goals,  $\theta$ ) returns a set of substitutions
inputs: KB, a knowledge base
           goals, a list of conjuncts forming a query ( $\theta$  already applied)
            $\theta$ , the current substitution, initially the empty substitution  $\emptyset$ 
local variables: answers, a set of substitutions, initially empty
if goals is empty then return  $\{\theta\}$ 
 $q' \leftarrow \text{SUBST}(\theta, \text{FIRST}(\textit{goals}))$ 
for each sentence r in KB
    where STANDARDIZE-APART(r) = ( $p_1 \wedge \dots \wedge p_n \Rightarrow q$ )
    and  $\theta' \leftarrow \text{UNIFY}(q, q')$  succeeds
     $\textit{new\_goals} \leftarrow [p_1, \dots, p_n | \text{REST}(\textit{goals})]$ 
     $\textit{answers} \leftarrow \text{FOL-BC-ASK}(\textit{KB}, \textit{new\_goals}, \text{COMPOSE}(\theta', \theta)) \cup \textit{answers}$ 
return answers
```

# logic programming

- Sound bite: computation as inference on logical KBs

## Logic programming

1. Identify problem
2. Assemble information
3. Tea break
4. Encode information in KB
5. Encode problem instance as facts
6. Ask queries
7. Find false facts

## Ordinary programming

- Identify problem ■
- Assemble information ■
- Figure out solution ■
- Program solution ■
- Encode problem instance as data ■
- Apply program to data ■
- Debug procedural errors

- Should be easier to debug *Capital(NewYork,US)* than  $x := x + 2!$

- Basis: backward chaining with Horn clauses + bells & whistles
- Widely used in Europe, Japan (basis of 5th Generation project)
- Compilation techniques  $\Rightarrow$  approaching a billion logical inferences per second
- Program = set of clauses = head `:- literal1, ... literaln.`

```
criminal(X) :- american(X), weapon(Y), sells(X,Y,Z), hostile(Z).
missile(M1).
owns(Nono,M1).
sells(West,X,Nono) :- missile(X), owns(Nono,X).
weapon(X) :- missile(X).
hostile(X) :- enemy(X,America).
American(West).
Enemy(Nono,America).
```

# Prolog Systems



- Efficient unification by **open coding**
- Efficient retrieval of matching clauses by direct linking
- Depth-first, left-to-right backward chaining
- Built-in predicates for arithmetic etc., e.g., `X is Y*Z+3`
- Closed-world assumption (“negation as failure”)  
e.g., given `alive(X) :- not dead(X).`  
`alive(joe)` succeeds if `dead(joe)` fails

# resolution

# Resolution: Brief Summary

- Full first-order version:

$$\frac{\ell_1 \vee \dots \vee \ell_k, \quad m_1 \vee \dots \vee m_n}{(\ell_1 \vee \dots \vee \ell_{i-1} \vee \ell_{i+1} \vee \dots \vee \ell_k \vee m_1 \vee \dots \vee m_{j-1} \vee m_{j+1} \vee \dots \vee m_n)\theta}$$

where  $\text{UNIFY}(\ell_i, \neg m_j) = \theta$ . ■

- For example,

$$\frac{\neg Rich(x) \vee Unhappy(x) \\ Rich(Ken)}{Unhappy(Ken)}$$

with  $\theta = \{x/Ken\}$

- Apply resolution steps to  $CNF(KB \wedge \neg\alpha)$ ; complete for FOL

Everyone who loves all animals is loved by someone:

$$\forall x [\forall y \text{ Animal}(y) \implies \text{Loves}(x,y)] \implies [\exists y \text{ Loves}(y,x)] \blacksquare$$

1. Eliminate biconditionals and implications

$$\forall x [\neg \forall y \neg \text{Animal}(y) \vee \text{Loves}(x,y)] \vee [\exists y \text{ Loves}(y,x)] \blacksquare$$

2. Move  $\neg$  inwards:  $\neg \forall x, p \equiv \exists x \neg p$ ,  $\neg \exists x, p \equiv \forall x \neg p$ :

$$\forall x [\exists y \neg(\neg \text{Animal}(y) \vee \text{Loves}(x,y))] \vee [\exists y \text{ Loves}(y,x)]$$

$$\forall x [\exists y \neg \neg \text{Animal}(y) \wedge \neg \text{Loves}(x,y)] \vee [\exists y \text{ Loves}(y,x)]$$

$$\forall x [\exists y \text{ Animal}(y) \wedge \neg \text{Loves}(x,y)] \vee [\exists y \text{ Loves}(y,x)]$$



# Conversion to CNF

3. Standardize variables: each quantifier should use a different one

$$\forall x [\exists y \textit{Animal}(y) \wedge \neg \textit{Loves}(x, y)] \vee [\exists z \textit{Loves}(z, x)] \blacksquare$$

4. Skolemize: a more general form of existential instantiation.

Each existential variable is replaced by a **Skolem function** of the enclosing universally quantified variables:

$$\forall x [\textit{Animal}(F(x)) \wedge \neg \textit{Loves}(x, F(x))] \vee \textit{Loves}(G(x), x) \blacksquare$$

5. Drop universal quantifiers:

$$[\textit{Animal}(F(x)) \wedge \neg \textit{Loves}(x, F(x))] \vee \textit{Loves}(G(x), x) \blacksquare$$

6. Distribute  $\wedge$  over  $\vee$ :

$$[\textit{Animal}(F(x)) \vee \textit{Loves}(G(x), x)] \wedge [\neg \textit{Loves}(x, F(x)) \vee \textit{Loves}(G(x), x)]$$

# Our Previous Example

- Rules

- $American(x) \wedge Weapon(y) \wedge Sells(x, y, z) \wedge Hostile(z) \implies Criminal(x)$
- $Missile(M_1)$  and  $Owns(Nono, M_1)$
- $\forall x Missile(x) \wedge Owns(Nono, x) \implies Sells(West, x, Nono)$
- $Missile(x) \implies Weapon(x)$
- $Enemy(x, America) \implies Hostile(x)$
- $American(West)$
- $Enemy(Nono, America)$

- Converted to CNF

- $\neg American(x) \vee \neg Weapon(y) \vee \neg Sells(x, y, z) \vee \neg Hostile(z) \vee Criminal(x)$
- $Missile(M_1)$  and  $Owns(Nono, M_1)$
- $\neg Missile(x) \vee \neg Owns(Nono, x) \vee Sells(West, x, Nono)$
- $\neg Missile(x) \vee Weapon(x)$
- $\neg Enemy(x, America) \vee Hostile(x)$
- $American(West)$
- $Enemy(Nono, America)$

- Query:  $\neg Criminal(West)$

# Resolution Proof

